

**Ladder, 36" Heavy Duty 5 Step, product number 36403-36**

**Rails**

The ladder shall be fabricated of 1.50" O.D. x .083", or .120" wall thickness 316L stainless steel. Each rail shall have three bends that are to be wrinkle free. Provided with two (2) rubber bumpers.

**Steps**

Five (5) step treads shall be provided. They shall be 19.66in wide x 5.00in deep, have a non-slip top surface, and shall be made of high density plastic. Hardware included.

**Anchors**

The ladder shall be supported by two (2) 4" bronze wedge anchors and two (2) stainless steel keyhole escutcheons. (Not Included)

**Warranty**

Two year limited warranty.

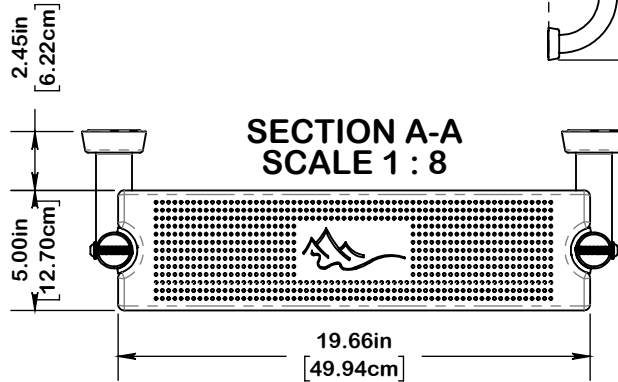

*NOTE:*

*⚠ DIMENSIONS VARY WITH SPECIFIC APPLICATIONS. SPECIFICATIONS ARE NOMINAL AND ARE SUBJECT TO CHANGE. PLEASE CONTACT SPECTRUM AQUATICS FOR CUSTOM APPLICATIONS*



A PLAYCORE Company

7100 Spectrum Lane  
 Missoula, Montana 59808  
 800.791.8056  
 www.spectrumaquatics.com

**ENGINEERING DATA**

PRODUCT:	36in HEAVY DUTY 5 STEP - 1.5 -			
MODEL #:	LADDER	CATALOG #:	36403-36	REVISION: A
MATERIAL:	316L STAINLESS STEEL			
FINISH #:	BUFFED TO NEAR #6 FINISH OR 500 GRIT			