

Ladder, 30" Standard 5 Step, product number 35135-30

Rails

The ladder shall be fabricated of 1.50" O.D. x .083", or .120" wall thickness 316L stainless steel. Each rail shall have three bends that are to be wrinkle free. Provided with two (2) rubber bumpers.

Steps

Five (5) step treads shall be provided. They shall be 19.66in wide x 5.00in deep, have a non-slip top surface, and shall be made of high density plastic. Hardware included.

Anchors

The ladder shall be supported by two (2) 4" bronze wedge anchors and two (2) stainless steel keyhole escutcheons. (Not Included)

Warranty

Two year limited warranty.

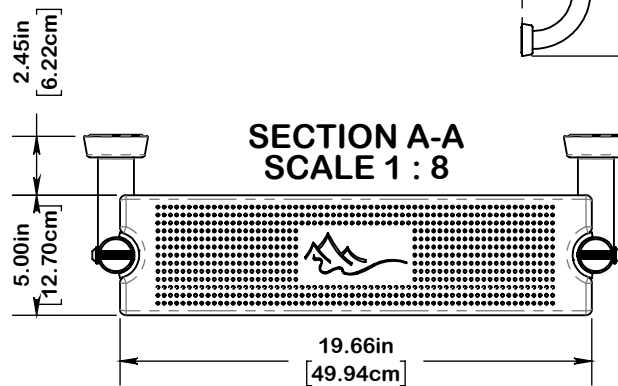

NOTE:

⚠ DIMENSIONS VARY WITH SPECIFIC APPLICATIONS. SPECIFICATIONS ARE NOMINAL AND ARE SUBJECT TO CHANGE. PLEASE CONTACT SPECTRUM AQUATICS FOR CUSTOM APPLICATIONS



A PLAYCORE Company

7100 Spectrum Lane
 Missoula, Montana 59808
 800.791.8056
 www.spectrumaquatics.com

ENGINEERING DATA

PRODUCT:	30in STANDARD 5 STEP - 1.5 -			
MODEL #:	LADDER	CATALOG #:	35135-30	REVISION: A
MATERIAL:	316L STAINLESS STEEL			
FINISH #:	BUFFED TO NEAR #6 FINISH OR 500 GRIT			