

**GRAB RAILS  
MODEL - BURBOT 30"**

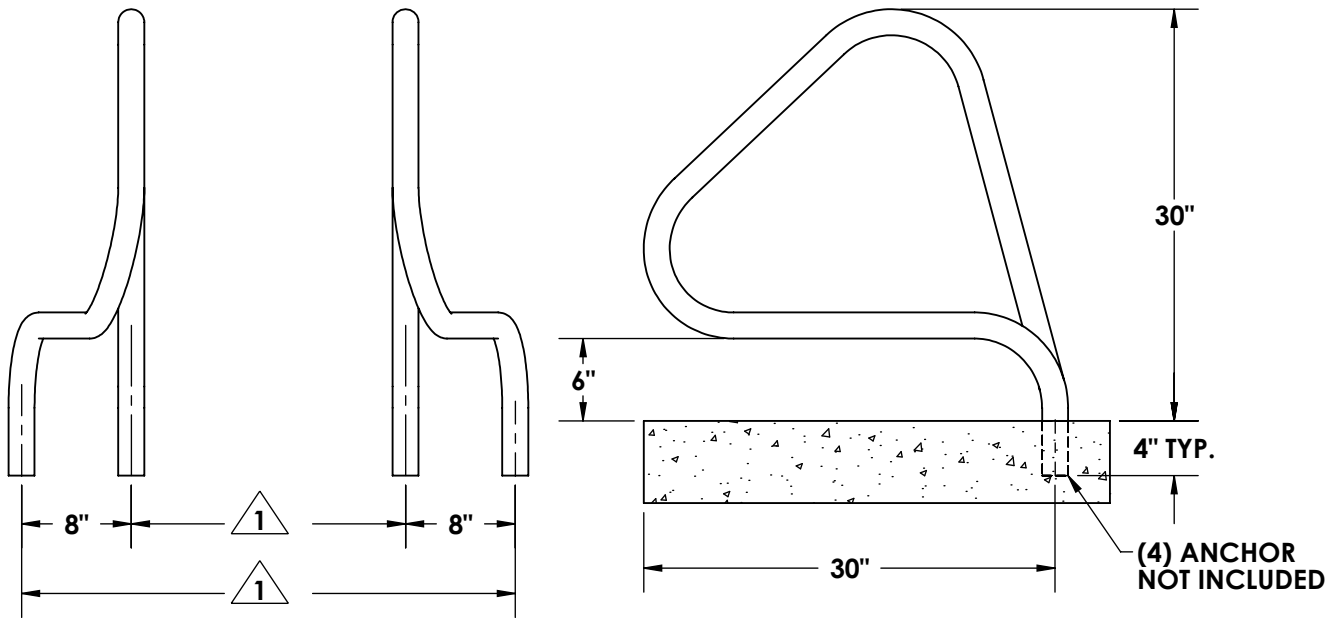

**NOTE:**

**1** DIMENSIONS VARY WITH SPECIFIC APPLICATIONS.  
SPECIFICATIONS ARE NOMINAL AND ARE SUBJECT TO CHANGE.  
PLEASE CONTACT SPECTRUM AQUATICS FOR CUSTOM APPLICATIONS.

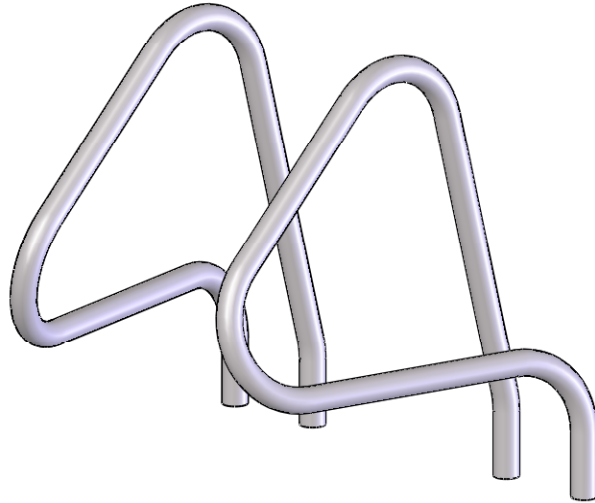

7100 Spectrum Lane  
Missoula, Montana 59808  
406.542.9781 \* 800.791.8056  
Fax: 406.542.1158  
www.spectrumproducts.com

**ENGINEERING DATA**

PRODUCT:	BURBOT 30"
PRODUCT #:	35110-.120
REVISION:	A
MATERIAL:	300 SERIES STAINLESS STEEL